

IZM-801CS4

Thank you for choosing WRT. Please read this manual before using. WRT reserves the right to change specifications or designs described in this manual without notice and obligation.

Content

1.0 Features&Functions-----	1
2.0 Equipment Description -----	2
Gate Station -----	2
3.0 Caution -----	3
4.0 Installation -----	4~5
5.0 Operation -----	6~22
6.0 Specification -----	23
7.0 Terminal Description -----	24
8.0 Trouble Shooting -----	25
9.0 Wiring -----	26~28

WRT®

Content

801 intercom systems is composed by building gate station, user door phone, PC and other equipments, which is based on TCP/IP. The system is with the technology of multichannel, every channel can work independently.

1. Luxury design, Max. capacity 400,000 cards,500,000 door phones.
2. Color video.
3. 4. 0"LCD Display
4. Digital audio video coding.
5. Multichannel,Guard Center can call other spare door phones while Gate Station are talking with door phone.
6. Divert,No-Disturb,multi-monitors and multi-centers,choose center automatically
7. Can call & talk with Guard Center which can remote unlock.
8. Unlock by password or cards , disarm by cards
9. **Snapshot** function (optional) 。
10. Burglar alarm (optional) ;
11. Door contact alarm;
12. Lift call function (optional) ;
13. CCD with night infrared compensation;
14. TCP/IP Agreement, network, remote system upgrade

Gate Station

Front View

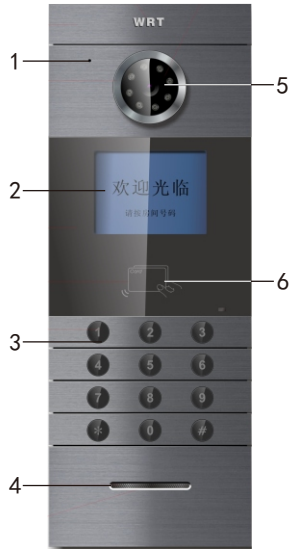

Back View

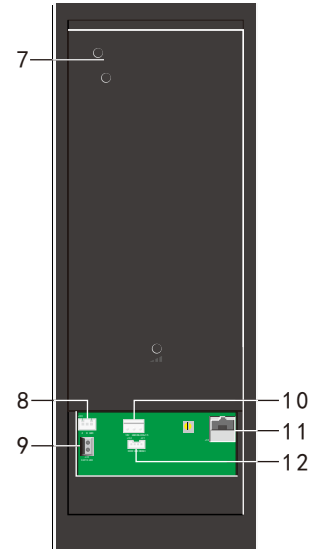

1. Microphone 2. LCD Display 3. Keypad 4. Speaker 5. Camera with IR compensation
6. IC card induction zone 7. Camera adjustment 8. Socket for lift control or access control
9. Lightning terminal (GND) 10. Socket for power input+unlock signal output
11. To network switch connector
12. Socket for door contact and door release.

1. Avoid direct sunlight, extreme temperature, frost, chemical erosion or dust.
2. Please confirm the height to install the station so that the visitor is within the vision of the camera.
3. Cut off the power when installing the system.
4. Make sure the wall or surface where the station installed is flat so as to avoid dust or water.
5. System wire should adopt CAT 5.
6. Separate strong electricity from the weak. Keep away from the elevator and TV cables (over 50m). Use iron tube and do not use the same wire tube for strong and weak electricity. The ends of the iron tube should be buried in 3m deep down the ground so as to raise capability of anti-jamming and lightning.
7. There is an - EARTH-GND socket on the back of gate station, it is lightning terminal, should be earthing (any one is ok) so as to avoid undesirable effects.
8. In order to avoid interference, it is better to use wire tube and separate other interferences. For easy maintenance and stability, all wire ends should not be installed in the wire tube or place where is humid.
9. Turn on the power supply after installing the whole system well.
10. Keep IC card be water-resistant, antimagnetic, antifluting.
11. Keep the IC induction zone clean, in order to enhance reliability to identify information.
12. For the first usage, access control data in the Door Station should be cleared to initialize the memorizer.
13. If the system is found of any malfunction, please cut off the power and inspect according to the Trouble Shooting. If it is unable to find the causes, please contact the sales agent or the manufacturer's after-sales service department. Do not repair or replace the parts by yourself, otherwise the system may be damaged.

Flush mounting

1. Drill holes at the suitable place on the front and the back of the door according to the size (Figure 1).
2. Unscrew 4 screws from Gate Station.(Figure 2).

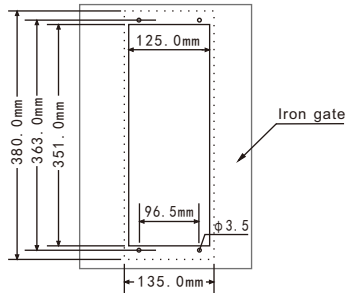

(1)



(2)

3. Drill a wire hole at the bottom case, insert the transmission wires through the wiring hole, Connecting all wires and press the Gate Station from the front of the door. Fix the bottom case with screws.

4. Fix Gate Station with screws.

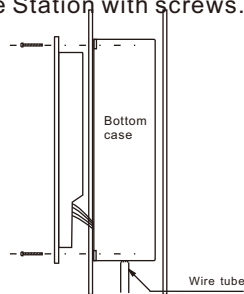

(3)



(4)

1. Make a hole in the wall prefer to the dimension of 135x380x67mm. The bottom of the hole shall be 150cm to 155cm above the ground.
2. Make a wiring hole on the bottom case and insert the wires through it, install the bottom case into the wall and embed it in the cement.

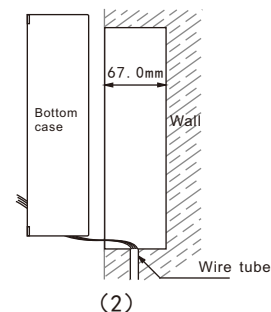
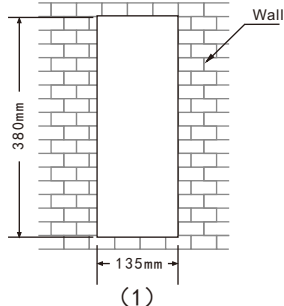

3. Unscrew 4 screws from Gate Station and separate aluminium sheet.
4. Connecting all Gate Station wires, then fix Gate Station on the bottom cover.
5. Fix the aluminium sheet with screws.



Operation

Please note:

- 1.All the parameters should be configured by appointed or authorized person in case of any data leakage. Admin password must be kept by specially-assigned person for usage or updating purpose.
- 2.Access control settings of gate station and wall station in the network system should be operated in center guard unit.
- 3.Back up a copied data file in case of any damage of computer system.
- 4.Every twice press the button not more than 30s, or it will exit operating state.

When standby, the screen will show:



The Gate Station works after all parameters are correct. Press "*" first, then press "#", and release the two keys at the same time, The screen will show:

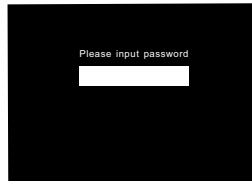

Input 1-8 digits managing PIN setting last time (If it is first time to input, it should be input the original PIN "88888888") and press "*". If press correct, it will be setup state:

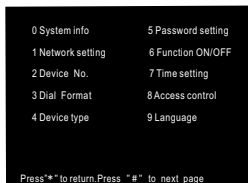

Press "#" to enter next page:

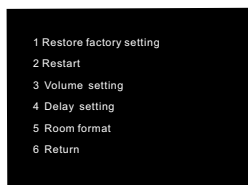

User press number keys before the items to enter the related interface of parameter configuration .

System info: Check the network parameter and other information.

Press "0" on the basic setting menu, the screen will show:

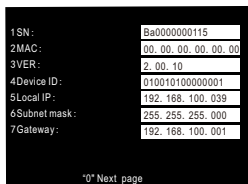

Press "0" to check next page, press "*" to return.

Network setting: Configure or modify the local network parameter.

Press "1" on the basic setting menu, the screen shows:

Operation

1 Local IP	192.168.100.001
2 Subnet mask	255.255.255.000
3 Gateway	192.168.100.001
4 Center IP	192.168.100.005
5 Back up center	000.000.000.000
6 Master Station	000.000.000.000
7 Sub Master Station	192.168.100.005
8 Return	000.000.000.000

Press number key, it can clear up the data in the related input box and input network parameters according to actual distribution. After finished input the data each time, if the data is legal, the screen will prompt that modify successfully and activate the next input box automatically. when non-input status, press "8" or "*" to return to previous menu or exit automatically after 60 seconds. Note: Network setting must be conducted by professional person. Other people can not setting or modify to avoid damaging the Gate Station.

If there are no backup Center IP,back up Master Station etc.,other IP address no need to input. Press "*" to clear up the data in the input box or exit input status.

Device NO.:

Press "2" on the basic setting menu, the screen shows:

1 Group NO.	01
2 Building NO.	001
3 Unit NO.	01
4 Local NO.	01
5 Return	

Press number keys,it can clear up the data in the related input box and input network parameters according to actual distribution. After finished input the data each time, press "#" to confirm, the screen will prompt that modify successfully and activate the next input box automatically. when

input the parameters, the interface will request to select digit or alphabet(except "0"),for example, "1:1 2:A".Press"1" to select serial number as digit, press"2" to select serial number as alphabet.

When non-input status, press "5" or "* " to return to previous menu or exit automatically after 30s

Note:Gate Station NO.is composed of 2 digits group NO.+3 digits building NO.+2 digits unit NO.+2 digits local NO. , When input should be based on this principle,if digits are not enough ,it could add "0" in front.

Press"*"to clear up the data in the input box or exit input status.

Dial Format:

Press"3"on the basic setting menu, the screen shows:

1 Group NO. digit	1
2 Building NO. digit	1
3 Unit NO. digit	1
4 Floor NO. digit	1
5 Room NO. digit	1
6 Return	1

Room NO, of tenant adopt 13-digit encode(2-digit group NO. + 3-digit building NO. + 2-digit unit NO. + 3-digit floor NO. + 3-digit room NO.).For example, group NO. digit is 0,building NO. digit is 0,unit NO. digit is 0,floor NO. digit is 1,room NO. digit is 1,when Gate Station calls floor 1 room 1, input "11#"can call this tenant. If floor NO. digit is 2,input"011#".

Press number keys,it can clear up the data in the related input box and input network parameters according to actual distribution. After finished input the data each time, if the data is legal, the

Operation



screen will prompt that modify successfully and activate the next input box automatically. Non-input status,press"6" or "*" can return to previous menu or exit automatically after 30s.
Note: Press"*"to clear up the data in the input box or exit input status.

Device type

Press "4" on the basic setting menu, the screen shows:

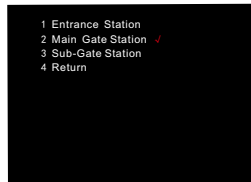

Press the device you want(" ✓" means selected),press"# " to confirm,the screen will prompt modify successfully.Press"*" to return to previous menu.

Password setting: set local super password and unlock password.

Press"5" on the basic setting menu, the screen will show:

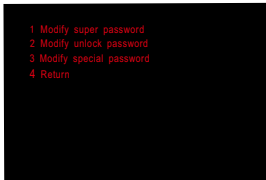

Operation

a. Modify super password



Input 1–8 digits new password . Then the screen prompt to confirm super password again. If entered two new super passwords are the same,it will prompt that new super password is modified successfully.

Note: Original password is "88888888"

Must use new password when enter setting menu.

b.Modify unlock password

Press"2" on password setting interface to the menu:



Operation

Input 6 digits new password. Then the screen prompts to confirm unlock password again. If entered two new unlock passwords are the same, it will prompt that new unlock password is modified successfully.

Note: Original password is "0000000", new password is 6-digit.

c. Modify special password

Press "3" on password setting interface to the menu:



Input room NO. (Former 3-digit is floor NO., last 3-digit is room NO.), press "#" to confirm, the screen shows:

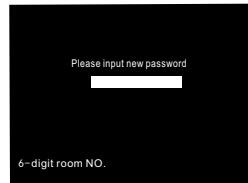

Input 6 digits new password, press "#" to confirm. Then the screen prompts to confirm special password again, tenant input new password again, press "#" to confirm. If entered two new special passwords are the same, it will prompt that new special password is modified successfully.

Note: New password is 6-digit.

Function ON/OFF

Press "6" on the basic setting menu, the screen will show:

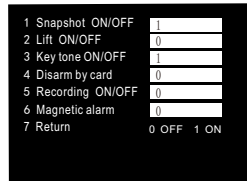

Snapshot ON/OFF: If this function enabled on Gate Station and Guard Center,when door phone call other tenant or Guard Center,Guard Center will snap a picture.

Lift ON/OFF: When system is connecting with lift,press"1" to activate lift control.Thus,when tenant unlock for Gate Station,lift will go to the place where Gate Station is.

Key tone ON/OFF: When key tone is on,each time press the key ,"Di" can be heard.

Disarm by card: When disarm by card is on,the tenant swipe the card to unlock and disarm door phone.

Recording ON/OFF: When this function enabled on IP door phone and Gate Station, Gate Station can leave message for the tenant.

Magnetic alarm: When Gate Station is connecting with door contact, enable magnetic alarm is suggested.Thus,if door release exceed delay time of door contact and not close the door,it will report the alarm to Guard Center.

Press number keys to clear up the data in the input box.Input "0" or "1" to set, press"#" to confirm,the screen will prompt that modify successfully and activate the next input box automatically.

Press"*" to exit input status.

Non-input status,press "7" or "*" to return to previous menu or exit automatically after 30s.

Operation

Time setting: Set the time of Gate Station.

Press "7" on the basic setting menu interface, the screen will show:

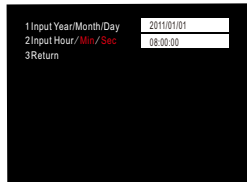

Press number keys to clear up the data in the input box, input the date and time, press "#" to confirm after finished, the screen will prompt modified successfully, it means the group data set successfully.

Under non-input state, press "3" or "*" to return previous or exit automatically after 30s.

Access control: It is effective for Gate Station with access control, including "issue card by room NO.", "issue card by swiping", "delete card by room NO." and "delete card by swiping".

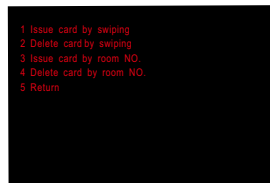

a. Issue card by swiping: Issue card by swiping for tenants.

On the “Access Control” interface, press “1”, the screen will show:

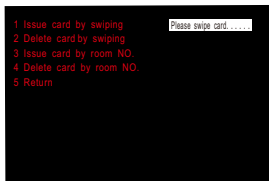

Swipe the card at the induction zone according to the prompt , the screen prompts modified successfully,it means the card issued successfully,the user could continue to swipe other cards.

Press “*”to return to previous menu.

b. Delete card by swiping: Delete card by swiping for tenants.

Press “2” on the “Access Control” interface,the screen will show:

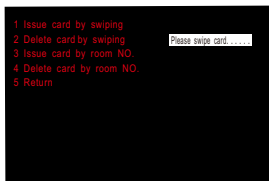

Swipe the card at the induction zone according to the prompt ,the screen prompts modified successfully,it means the card deleted successfully,the user could continue deleting other cards.

Press “*” to return to previous menu.

c. Issue card by room NO. : Issue card by room NO. of the tenant.

Press “3” on the “Access Control” interface,the screen will show:

Operation

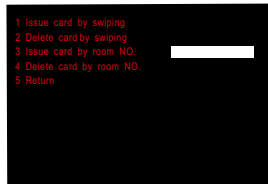

Input 6 digits (3-digit floor NO.+ 3-digit room NO.,for example 001001) the room NO.of tenant. Press"#",again, then swipe the card at induction zone,it means issued successfully,the user could continue inputting other room NO. to issue other cards.Press "*" to return to previous menu.

d. Delete card by room NO. : Delete card by room NO. of the tenant.

Press "4" on the "Access Control"interface,the screen will show:

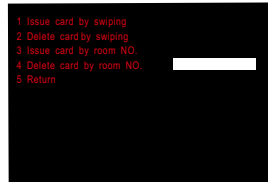

Input 6 digits(3-digit floor NO.+ 3-digit room NO.,for example 001001) the room NO.of tenant. Then press"#",to confirm,it means deleted successfully.

Note:The tenant could use the card which is issued successfully to unlock.

The card which is deleted will become invalidly,can not open the electric lock,until the card is registered again.

Language:

There are two languages for option: English and Chinese.

Restore factory setting: All the settings are initialized, please be cautious!

Press "1" on the basic setting menu on page 2, the screen will show:

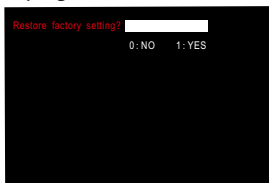

Press "1", then press "#", all the settings are initialized, Gate Station will restart automatically.

Restart

Press "2" on the basic setting menu on page 2, the screen will show:

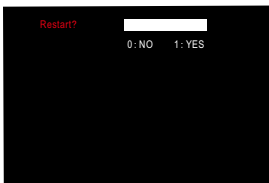

Press "1", then press "#", Gate Station will restart automatically.

Volume setting

Press "3" on the basic setting menu on page 2, the screen will show:

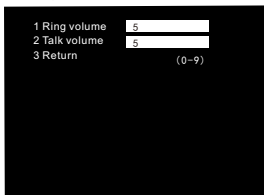

Operation

Press number keys to clear up the data in the input box. Input "0-9" to set, press"#" to confirm, the screen will prompt that modify successfully and activate the next input box automatically.

Press"*" to exit input status.

Non-input status,press "3" or "*" to return to previous menu or exit automatically after 30s.

Delay setting

Press"4"on the basic setting menu on page 2,the screen will show:

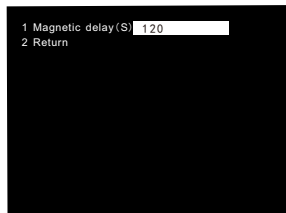

Press "1" to clear up the data in the input box. Input delay time(Max. 300), press"#" to confirm, the screen will prompt that modify successfully.

Press"*" to exit input status.

Non-input status,press "2" or "*" to return to previous menu or exit automatically after 30s.

Room format

Press"5"on the basic setting menu on page 2,the screen will show:

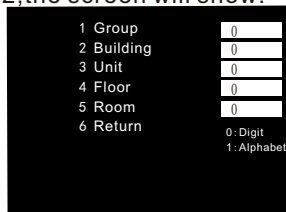

Press number keys to clear up the data in the input box. Input "0" or "1" to set digit or alphabet, press "#" to confirm after each time input, the screen will prompt that modify successfully and activate the next input box automatically.

Non-input status, press "6" or "*" to return to previous menu or exit automatically after 30s.

Note: During input, press "*" to clear up the data in the input box or exit input status.

Magnetic Alarm:

There is a magnetic terminal MENC1, GND on the socket J24 which is at the back of Gate Station, it is used to connect magnetic, when MENC1 and GND are open more than the magnetic delay time and no short circuit, it will report the alarm. no short circuit, it will report alarm.

Note: There is a magnetic terminal DOOR and GND on the socket J24 which is at the back of Gate Station, it is used to connect with unlock button, when DOOR and GND are short circuit, can release the door.

After all settings are completed, please restart Gate Station to refresh data.

Operation

Calling Tenants(Divert off):

When standby, input room NO. (2 digits floor number and 2 digits room NO.), For example, calling room 2 on 3rd floor, input:0302, the screen display the corresponding number at the same time:

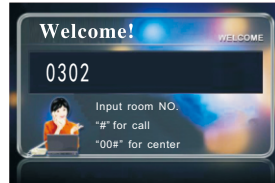

After finished input the room number,press"# "to confirm,if the number does not exist,if the screen will prompt:

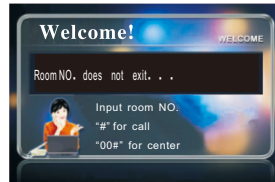

If the number is correct and the line is not busy,it will ring out,the screen will show:



When the tenant answers the phone,the screen will show:

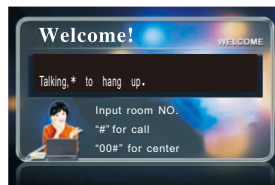

Visitors can talk with the tenant ,Press “* ” can hang up .

If the conversation last over 120 seconds, the system will return to standby state automatically.

The tenant can unlock the electric door by pressing the “unlock” key while talking,the screen will show:



If there is no answer while calling the tenant over 30 seconds, the system will return to standby state automatically.

When Gate Station is calling the tenant,door phone is IP system and Gate Station with message function,if time out and no one answer the call,Gate Station will prompt”Press”#” to leave a message in 5s,others to hang up”,visitor can press ”#” to leave message for tenant,the screen display the countdown.

Calling Tenants(Divert on):

When the station calls the tenant and the line is not busy,the system will transfer the call to Guard

Operation

Center. You can also leave a message to Guard Center, the message will be delivered to the household.

Calling Center:

Press "00#", you can call the Center (sequence of call: Master Station > Sub Master Station > Guard Center > Back up Guard Center)

If the center is free, the screen will show:



If there is no answer within 30s, system will be back to normal automatically.

If someone answers, the call can last 120 seconds.

Unlock the door by Guard Center while talking.

If divert on, it will transfer the call to the Center.

If the Center no answer or is busy, it will transfer the call to the Back up Center.

If the Center is busy, no Back up Center, it will prompt busy tone, please call later.

Unlock by password:

If the device is Entrance Station, tenant could unlock by password, The method is to input "*" + password + "#". For example, the unlock password is "000001", input "*000001" to unlock,

If input correct password, the screen will show:



If the device is Gate Station, tenant can use special password to unlock. The method is to input " * " Room NO. + password + " #".

When tenant use special password to unlock, input room NO. should according to dial format. For example, dial format is 1-digit floor NO. + 1-digit room NO. , it is floor 01 room 1. The tenant with special password is 000002 should input " *11000002#".

Unlock by Access Control card:

When standby, the tenant use IC card to close to the induction zone. "Du "tone can be heard if succeed , the screen will show:

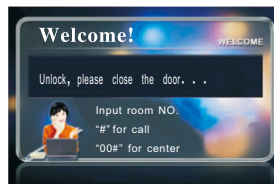

If IC card fails validation, "Du Du"tone can be heard, the screen will prompt invalid card.

Direct Voltage	+18VDC
Static Current	≤290mA
Working Current	≤370mA
Operating Temperature	-30°C~+55°C
Humidity	45%~95%
Distortion	≤5%
Sensitivity	≤30mV
Camera	5-16U. 500 wire. Automatic backlight compensation
Signal System	PAL
Resolution	320 (RGB) x240
LCD	4.0 inch
Conversation Time	About 120s
Wire type.....	1* CAT5+1*RVV3X1.0mm ² power wire
Network port	RJ45
Protocol	TCP/IP
Wiring distance	Use a network switch or router in 100m, add a fiber optical transceiver over
IC Access Time	<100ms
IC Access Distance	≤20mm
Capacity of cards	3000
Protection Grade.....	IP33
Dimensions.....	147×393×80mm (Including bottom case)
Size of Bottom case	133×377×65mm

Terminal Description

Terminal Marks		Description
J21	18V	Power supply input +, supply DC +18V for the station
	GND	Power supply input-
	UNLOCK	Unlock signal output, +12V when unlock
J24	DOOR	Unlock signal input
	GND	GND
	MENIC	To door contact
J20	A	485A data wire
	B	485B data wire
	GND	GND
J13		To network switch

Description	Check	Solution
Gate Station does not work	<ol style="list-style-type: none"> 1. Check the power supply 2. Check the wire connection between Gate Station and power supply 	Connect wires between Gate Station and power supply correctly
Cannot connect to network	<ol style="list-style-type: none"> 1. Check the network port and connection of network wire. 2. Check the IP 	Connect network wires correctly and set the correct IP
Cannot Unlock	<ol style="list-style-type: none"> 1. Check wire connection between Gate Station and power supply. 2. Check wire connection between electric lock and power supply. 2. Check if electric lock is match 3. Check connection of network wire. 	<ol style="list-style-type: none"> 1. Use PIN to release door, if it works, the problem is the wiring between Gate Station and system. 2. If PIN cannot release door, please test if there is +12V between LOCK of Gate Station and NO port of system power supply when release door. If no voltage in LOCK, please change Gate Station. If there is voltage in NO, please change electric lock. If no, please check the wire connection and power supply.
IC Card Cannot release the door	<ol style="list-style-type: none"> 1. If the card is registered 2. If the card is damaged 3. Using the card in correct way 4. The station does work 	<ol style="list-style-type: none"> 1. If just only one card does not work, register the card. 2. If all the cards does not work, check the wiring of Gate Station.

Wiring

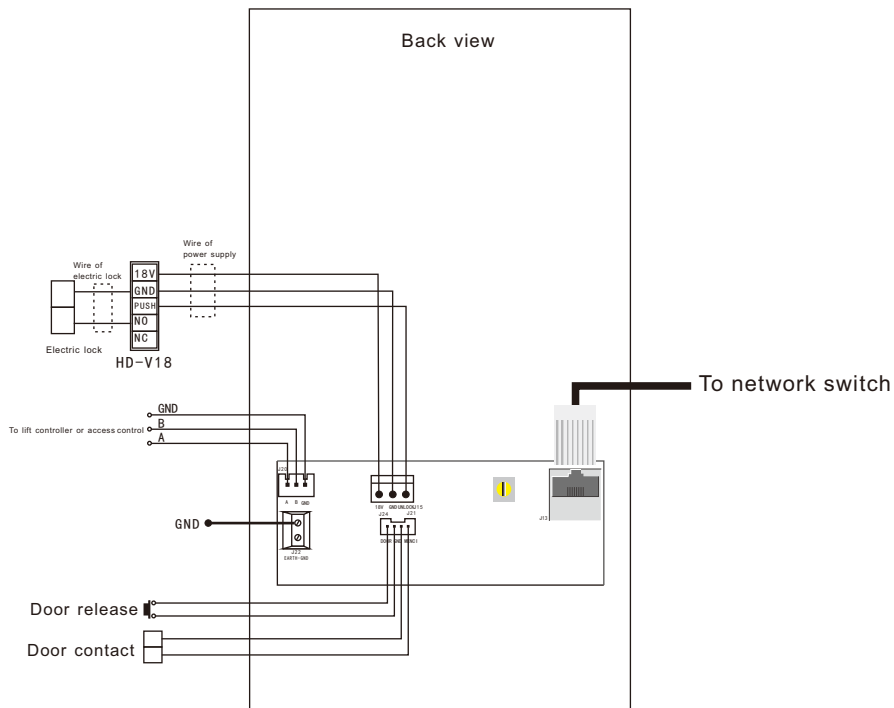

Note: There 2 ways of electric lock:unlock when energized and unlock when power off,please connect according to actual situation..

Manufacturer

Shenzhen WRT Intelligent Electrical Appliance Co.,Ltd

Add: WRT Industrial Base, Dafu Industrial Park, Guanguang Rd,
GuanLan Town, BaoAn District, ShenZhen, China

Tel: +86 755 29576113

Fax: 86 755 29576023

Http:www.wrtsz.com