

# CAT5 intercom system gate station manual

WRT<sup>®</sup>

# UZM-212S3-IPM

Thank you for choosing WRT. Please read this manual before using. WRT reserves the right to change specifications or designs described in this manual without notice and obligation.

# Content

1.0 Features&Functions	1
2.0 Equipment Description	2
Audio Gate Station	2
Video Gate Station	3
3.0 Caution	4
4.0 Installation	5~6
5.0 Operation	7~23
6.0 Specification	24
7.0 Terminal Description	25
8.0 Trouble Shooting	26
9.0 Wiring	27~29

WRT®

Content

CAT5 Intercom System is composed by building gate station, user door phone, PC and other equipments, which is based on TCP/IP. The system is with the technology of multichannel, every channel can work independently.

1. Suit for CAT5 Intercom System.
2. Max capacity is 1016 door phones;
3. Color video;
4. 3.5"LCD Display;
5. Soft coding form, it is freed from building structure;
6. Fashion keyboard with button, dust proof, long service life (optional) ;
7. Can call /talk with Guard Center and Guard Center can remote unlock.
8. Unlock by cards;
9. Snapshot function (optional) 。
10. Burglar alarm (optional) ;
11. Door contact alarm;
12. Lift control (optional) ;
13. CCD with night infrared compensation;
14. TCP/IP Agreement, network, remote system upgrade

# Audio Gate Station

## Front View

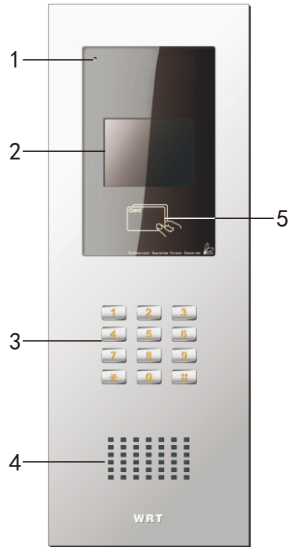

## Back View

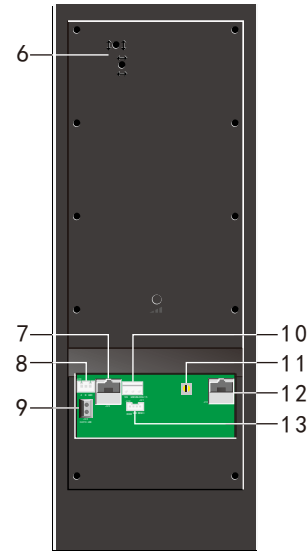

1. Microphone

2. LCD Display

3. Keypad

4. Speaker

5. IC card induction zone

6. Camera adjustment

7. To decoder connector

8. Socket for access control or lift controller

9. Lightning terminal (GND)

10. Socket for power input+unlock signal output

11. Volume adjustment

12. To network switch connector

13. Socket for door contact and door release

WRT®

2

Equipment description

Video Gate Station

Front View

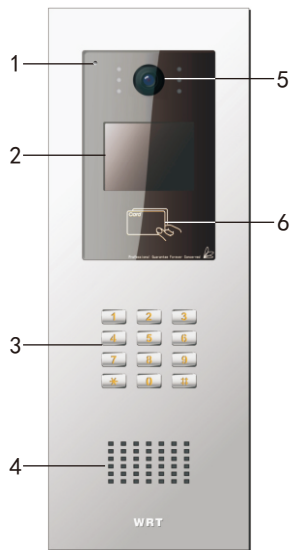

Back View

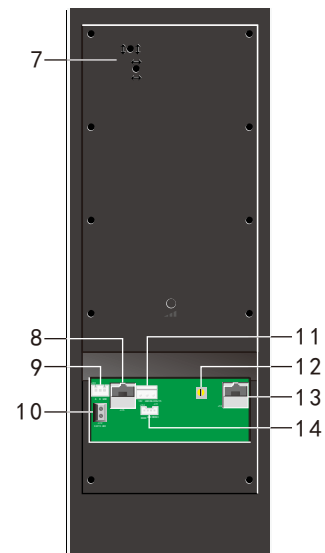

- 1. Microphone    2. LCD Display    3. Keypad    4. Speaker    5. Camera with IR compensation
- 6. IC card induction zone    7. Camera adjustment    8. To decoder connector
- 9. Socket for access control or lift controller    10. Lightning terminal (GND)
- 11. Socket for power input+unlock signal output    12. Volume adjustment
- 13. To network switch connector    14. Socket for door contact and door release

# Caution

1. Avoid direct sunlight, extreme temperature, frost, chemical erosion or dust.
2. Please confirm the height to install the station so that the visitor is within the vision of the camera.
3. Cut off the power when installing the system.
4. Make sure the wall or surface where the station installed is flat so as to avoid dust or water.
5. System wire should be shielded wire, gauze screen of shielded wire should be connected with GND, but not connected with the ground.
6. There is an - EARTH-GND socket on the back of gate station, it is lightning terminal, should be earthing (any one is ok) so as to avoid undesirable effects
7. If there is a tamper switch, the tamper switch must keep close to bottom case while installing to avoid misinformation.
8. The ground wire should use insulated copper wire whose cross-sectional area not less than  $1.5\text{mm}^2$ , ground resistance should not more than 10 ohm.
9. Separate strong electricity from the weak. Keep away from the elevator and TV cables (over 50m). Use iron tube and do not use the same wire tube for strong and weak electricity. The ends of the iron tube should be buried in 3m deep down the ground so as to raise capability of anti-jamming and lightning.
10. In order to avoid interference, it is better to use wire tube and separate other interferences. For easy maintenance and stability, all wire ends should not be installed in the wire tube or place where is humid.
11. Turn on the power supply after installing the whole system well.
12. Keep IC card be water-resistant, antimagnetic, antifluting.
13. Keep the IC induction zone clean, in order to enhance reliability to identify information.
14. For the first usage, access control data in the Door Station should be cleared to initialize the memorizer.
15. If the system is found of any malfunction, please cut off the power and inspect according to the Trouble Shooting. If it is unable to find the causes, please contact the sales agent or the manufacturer's after-sales service department. Do not repair or replace the parts by yourself, otherwise the system may be damaged.

1. Drill holes at the suitable place on the front and the back of the door according to the size (Figure 1).
2. Unscrew 4 screws from Gate Station.(Figure 2) .

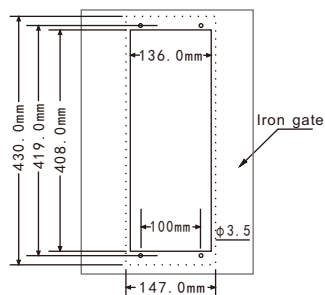

(1)



(2)

3. Drill a wire hole at the bottom case and insert the wires through the wiring hole, put a waterproof ring on the Gate Station( distinguish the right and wrong side ). Connecting all Gate Station wires, then fix Gate Station on the bottom cover.(Figure 3)
4. Fix Gate Station with screws.

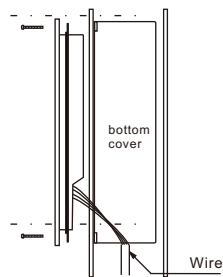

(3)



(4)

# Flush-mount install

1. Make a hole in the wall prefer to the dimension of 148x432x82mm. The bottom of the hole shall be 150cm to 155cm above the ground.(Figure 1)
2. Make a wiring hole on the bottom case and insert the wires through it, install the bottom case into the wall and embed it in the cement.(Figure 2).

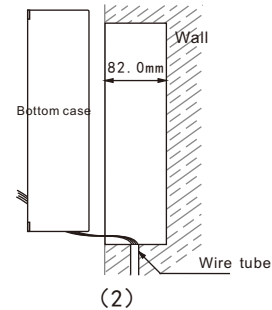
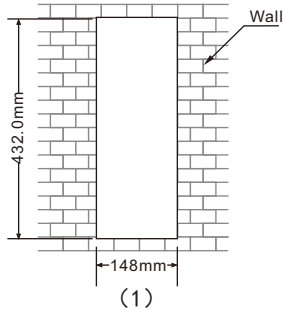

3. Unscrew 4 screws from Gate Station and separate aluminium sheet.
4. Put a waterproof ring on the Gate Station( distinguish the right and wrong side )
5. Connecting all Gate Station wires, then fix Gate Station on the bottom cover and the aluminium sheet with screws.





Please note:

- 1.All the parameters should be configured by appointed or authorized person in case of any data leakage. Admin password must be kept by specially-assigned person for usage or updating purpose.
- 2.Access control settings of gate station and wall station in the network system should be operated in center guard unit.
- 3.Back up a copied data file in case of any damage of computer system.
- 4.Every twice press the button not more than 60 seconds, or it will exit operating state.  
When standby, the screen will show:



The Gate Station works after all parameters are correct. Press "\*" first, then press "#", and release the two keys at the same time. The screen will show:

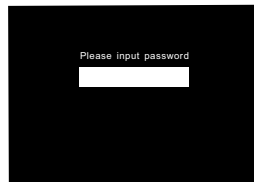

Input 8 digits managing PIN setting last time (If it is first time to input, it should be input the original PIN "88888888") and press "\*". If press correct, it will be setup state:

# Operation

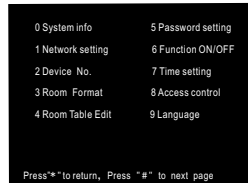

Press "#" to enter next page:

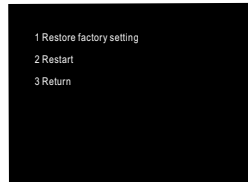

User press number keys before the items to enter the related interface of parameter configuration .

System info: Check the network parameter and other information.

Press "0" on the basic setting menu, the screen will show:

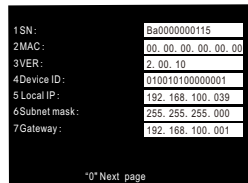

Press "0" to check next page, press "\*" to return.

Network setting: Configure or modify the local network parameter.

Press "1" on the basic setting menu, the screen shows:

1 Local IP	192.168.100.001
2 Subnet mask	255.255.255.000
3 Gateway	192.168.100.001
4 Center IP	192.168.100.005
5 Backup center	000.000.000.000
6 Guard Station	000.000.000.000
7 Sub Guard Station	192.168.100.005
8 Return	000.000.000.000

Press number key, it can clear up the data in the related input box and input network parameters according to actual distribution. After finished input the data each time, if the data is legal, the screen will prompt that modify successfully and activate the next input box automatically. when non-input status, press "8" or "\*" to return to previous menu or exit automatically after 60 seconds. Note: Network setting must be conducted by professional person. Other people can not setting or modify to avoid damaging the Gate Station.

If there are no backup Center ,sub Guard Station etc.,other IP address no need to input.

Press "\*" to clear up the data in the input box or exit input status.

Device NO.:

Press "2" on the basic setting menu, the screen shows:

1 Group NO.	01
2 Building NO.	001
3 Unit NO.	01
4 Local NO.	01
5 Return	01

Press number keys, it can clear up the data in the related input box and input network parameters according to actual distribution. After finished input the data each time, if the data is legal, the screen will prompt that modify successfully and activate the next input box automatically. when

# Operation

non-input status, press "5" or "\*" to return to previous menu or exit automatically after 60 seconds.

Note: Gate Station NO. is composed of 2 digits group NO. + 3 digits building NO. + 2 digits unit NO. + 2 digits local NO. , When input should be based on this principle, if digits are not enough, it could add "0" in front.

When local NO. is 01, it is Gate Station. When local NO. is anything else, it is sub Gate Station.

In a building, no matter how many outdoor stations, there must be a Gate Station named 01.

Press "\*" to clear up the data in the input box or exit input status.

Room Format:

Press "3" on the basic setting menu, the screen shows:

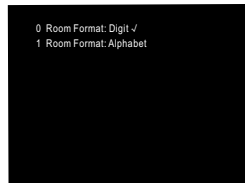

Press "0" or "1", select room format as digit or alphabet ("✓" means selected).

press "\*" to return previous menu or exit automatically after 60 seconds.

Room Table Edit :

Press "4" on the basic setting menu, the screen shows:

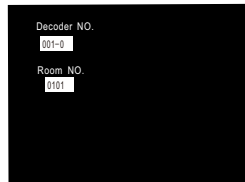

The "001-0" represents decoder and port number; "0101" represent room NO.. Input decoder number and its address code which need to modify, four digits room NO. is automatically generated. Then modify it to the room NO. you need. After finished, the screen shows next address code and room NO., it means previous modification has been finished, and continue to modify next room NO., repeat above program until complete.

Note: Address codes 0-7 correspond to ports 1-8.

During input, red characters means current modify position. Press "\*" to move one character forward or exit input status.

Case: There are 12 floors in this building, each floor 12 apartments. So each floor need more than one decoder. In order to modify floor and room NO. easily, the decoder 1 is used for room 0101-0108 on the 1st floor, the decoder 2 is used for room 0201-0208 on the 2nd floor, until the decoder 12 is used for room 1201-1208 on the 12th floor. Then the decoder 13 is used for room 9-12 on the 1st and 2nd floor, the decoder 14 is used for room 9-12 on the 3rd and 4th floor. Until the decoder 18 is used for room 9-12 on the 11th and 12th floor. Because the port number of decoder 1-12 correspond to actual room NO. automatically (the 001\_0-001\_7 address codes of decoder 1 correspond to output ports 1-8 room NO. are 0101-0108, matched actual room NO.), no need to be modified. But the room NO. of decoder 13-18 need to be modified (just like 013\_0-013\_7 address codes of decoder 13 correspond to output ports 1-8 room NO. are 1301-1308, but actual room NO. are 0109-0112, 0209-0212). When the screen enter to the process that room NO. setting, input "0130", room NO. will show 1301:

# Operation

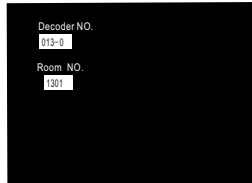

Input room NO."0109",it shows:

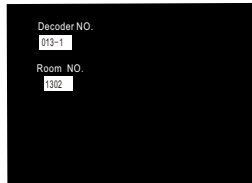

Thus, the first port of the decoder 13 had been modified to room NO.0109. Then input "0131 0110" (or press"#", input "0110" after moved the cursor 4 digits, following the same),"0132 0111", "0133 0112", modify the room NO. which correspond to output ports 2-4 to 0110-0112.Then modify the room NO. which correspond to output ports 5-8 to 0209-0212.

The modification of decoder 13 is completed. The modification of decoders 14-18 is the same as above.

Ports 1-8 of the decoders 01-99 which connect with Gate Station correspond to room NO. 01-08 automatically, Ports 1-8 of the decoders 100-127 correspond to room NO.09-16 automatically, port number which is anomalistic must be modified.

Password setting: set local super password and unlock password.

Press"5" on the basic setting menu, the screen will show:

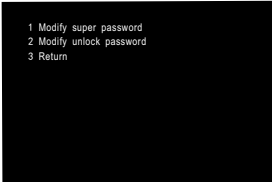

```
1 Modify super password
2 Modify unlock password
3 Return
```

a. Modify super password: modify local super password.

Press "1" on the interface of password setting to enter the menu of modify super password.



Please input new password

Input 8 digits new password . Then the screen prompt to confirm super password again. If entered two new super passwords are the same, it will prompt that new super password is modified successfully.

Note: Original password is "88888888"

Enter the setting menu again and must use new password

# Operation

Function ON/OFF: turn on or off for some special functions.

Press "6" on the basic setting menu, the screen will show:

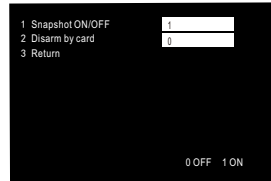

Press number keys to clear up the data in the input box. Input "0" or "1" to set, screen will prompt modified successfully, it means this group data set successfully.

Snapshot ON/OFF: whether to enable snapshot function.

If this function enabled on Gate Station and the center exit the room NO. address table of the tenant, the Entrance Station or sub Gate Station call the tenant in this unit 20 seconds, it will snap a picture



if there is no answer.

Disarm by card: Under the "Disarm by card" status, when the tenant swipes the card to open the door at the Gate Station, it also disarms the door phone.

Time setting: Set the time of Gate Station.

Press "7" on the basic setting menu interface, the screen will show:

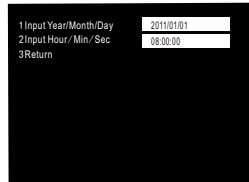

Press number keys to clear up the data in the input box, input the date and time, press "#" to confirm after finished, the screen will prompt modified successfully, it means the group data set successfully.

Under non-input state, press "3" or "\*" to return previous or exit automatically after 60 seconds.

Note: Time setting will not be saved. Time will be default after restart, but time synchronized through center after connecting the power supply.

Access control: It is effective for Gate Station with access control, including "issue card by room NO.", "issue card by swiping", "delete card by room NO." and "delete card by swiping".

A screenshot of a black screen with white text. The text is as follows:  
1 Issue card by swiping  
2 Delete card by swiping  
3 Issue card by room NO.  
4 Delete card by room NO.  
5 Return

# Operation

a. Issue card by swiping: Issue card by swiping for tenants.

On the “Access Control” interface, press “1”, the screen will show:

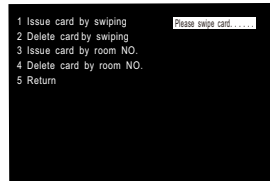

Swipe the card at the induction zone according to the prompt , the screen prompts modified successfully,it means the card issued successfully,the user could continue to swipe other cards. Press “\*”to return to previous menu.

b. Delete card by swiping: Delete card by swiping for tenants.

Press “2” on the “Access Control” interface,the screen will show:

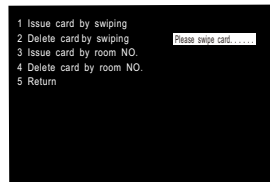

Swipe the card at the induction zone according to the prompt ,the screen prompts modified successfully,it means the card deleted successfully,the user could continue deleting other cards. Press “\*” to return to previous menu.

c. Issue card by room NO. : Issue card by room NO. of the tenant.

Press “3” on the “Access Control” interface,the screen will show:

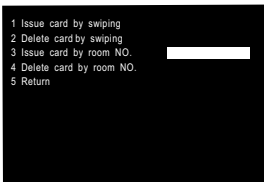

Input 6 digits (3-digit floor NO.+ 3-digits room NO.,for example 001001) the room NO.of tenant. Press”#”again, then swipe the card at induction zone,it means issued successfully,the user could continue inputting other room NO. to issue other cards.Press “\*” to return to previous menu.

Note:Before issuing card by room NO.,you must make sure center have added this room NO.,or it will prompt there is no this room NO.

d. Delete card by room NO. : Delete card by room NO. of the tenant.

Press “4” on the “Access Control”interface,the screen will show:

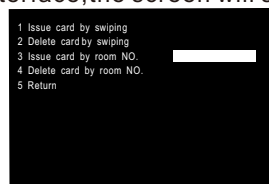

Input 6 digits(3-digit floor NO.+ 3-digits room NO.,for example 001001) the room NO.of tenant.

Then press”#”to confirm,it means deleted successfully.

Note:The tenant could use the card which is issued successfully to unlock.

The card which is deleted will become invalidly,can not open the electric lock,until the card is registered again.

# Operation

Language:

There are two languages for option: English and Chinese.

Restore factory setting: All the settings are initialized, please be cautious!

Press "1" on the basic setting menu on page 2, the screen will show:

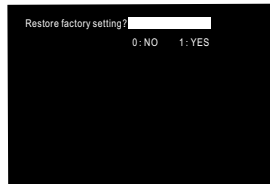

Press "1", then press "#", all the settings are initialized. Gate Station will restart automatically.

Note: Restore factory setting will delete all access control cards. Decoder room NO. table, serial number and network parameter will be default values. Please be cautious.

Restart: Restart Gate Station.

Press "2" on the basic setting menu on page 2, the screen will show:

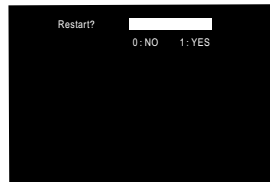

Press "1", then press "#", Gate Station will restart automatically.

Door contact Alarm:

There is a door contact terminal MENC1、GND at the socket J24 which is on the back of Gate

Station ,it is used to connect door contact, when MENC1 and GND open more than 120s without short circuit, it will report alarm.

Note:There is a volume adjust electronic equipment at the back of Gate Station.

There is a terminal DOOR and GND at the socket J24 which is at the back of Gate Station , it is used to connect to the button.When DOOR and GND are short circuit,can open the door. After all settings are completed,please restart Gate Station to refresh datas.

# Operation

Calling Tenants(Divert off):

When standby, input room NO. (2 digits floor number and 2 digits room NO.), For example, calling room 2 on 3rd floor, input:0302, the screen display the corresponding number at the same time:



After finished input the room number,press"#"to confirm,if the number does not exist, the screen will prompt:

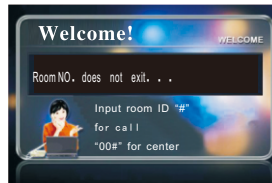

If the number is correct and the line is not busy,it will ring out,the screen will show:



When the tenant answers the phone,the screen will show:



Visitors can talk with the tenant ,Press “\* ” can hang up .

If the conversation last over 60s, the system will return to standby state automatically.

The tenant can unlock the electric door by pressing the “unlock” key while calling,the screen will show:



If there is no answer while calling the tenant over 30s, the system will return to standby state automatically.

Calling Tenants(Divert on):

When the station calls the tenant and the line is not busy,the system will transfer the call to Guard Center. You can also leave a message to Guard Center,the message will be delivered to the household.

Calling Center:

Press“00#”,you can call the Center(sequence of call:Guard Station>Sub Guard Station>Guard Center>Back up Guard Center)

# Operation

If the center is free, the screen will show:



If there is no answer within 30s, system will be back to normal automatically.

If someone answers, the call can last 60s.

Unlock the door by Guard Center while calling.

If divert on, it will transfer the call to the Center.

If the Center no answer or is busy, it will transfer the call to the Back up Center.

If the Center is busy,no Back up Center,it will prompt busy tone,please call later.

Unlock by password:

The tenant could unlock by password,The method is to input“ \* ” + passwords + “ #”.For example, the unlock password is "00000001", input"\*00000001"to unlock,

If input correct password,the screen will show:



Note:If unlock password is blank, you can not unlock by password.



Unlock by Access Control card:

When standby, the tenant use IC card to close to the induction zone. "Di Di" tone can be heard if succeed ,the screen will show:



If IC card failed to register, "Du Du" tone can be heard, the screen will prompt invalid card.

# Specification

Direct Voltage .....	+18VDC
Standtic Current .....	≤300mA
Working Current .....	≤380mA
Operating Temperature .....	-30°C~+55°C
Humidity .....	45%~95%
Distortion .....	≤5%
Sensitivity .....	≤30mV
Camera .....	5-16U. 500 wire. Automatic backlight compensation
Signal System .....	PAL
Resolution .....	320 (RGB) x240
LCD .....	3.5 inch
Conversation Time .....	About 60 seconds
Network port .....	RJ45
Protocol .....	TCP/IP
Transmission distance .....	For details, read the requirement of wire size
IC Access Time .....	<100ms
IC Access Distance .....	≤20mm
Capacity of cards .....	3000
Defence Grade .....	IP33
External Dimensions .....	167×451×95mm (Including bottom case)
Size of Bottom case .....	148×432×82mm

Terminal Marks		Description
J21	18V	Power supply input +, supply DC +18V for the station
	GND	Power supply input-
	UNLOCK	Unlock signal output, +12V when unlock
J24	DOOR	Unlock signal input
	GND	GND
	MENCI	To door contact
J20	A	485A data wire
	B	485B data wire
	GND	GND
J25		To decoder
J13		To network switch

# Trouble shooting

Description	Check	Solution
Gate Station can not call door phone	check the connection from Gate State to decoder.Can not call a door phone ,check the connection from door phone to decoder; please check whether the door phone is damaged	Connect all the wires correctly and change another Gate Station to test
Video door phone with grating but no photos	check the connection from Gate State to decoder if there are no photos in Gate Station.Check the connection from door phone to decoder if there are no photos in door phone; please check whether the door phone is damaged.	Connect all the wires correctly and change another door phone to test
Can not unlock by IC card	1.whether IC card is registered 2.whether IC card is damaged 3.whether the method of swiping card is correct and Gate State is damaged	The distance from IC card to induction zone must <30mm.If all the cards can not unlock, check the wires of Gate Station If just one card can not unlock,it means the card is not registered or deleted records or damaged.
All the tenants in a building can not unlock	Check connection from Gate Station to power supply and from power supply to electric lock,whether electric lock match (our system is high unlock) whether wiring of Gate Station is connected.	If unlock by password,check whether wiring is connected correctly.If can not unlock,check Gate Station LOCK and system power supply terminal NO+12V voltage output when unlock,If there is no voltage at the LOCK position, change Gate Station. If there is voltage at the NO position, change electric lock.If there is no voltage at the NO position,check whether wiring is connected correctly and power supply is damaged

# Wire size

Type	Wiring Description		Requirements			Remark	
System power supply wire	Wire between system power supply and Gate Station		1~20m	20~50m	50~100m	Please pay attention to transmission distance and wire size	
			RVV3×0.75mm <sup>2</sup>	RVV3×1.0mm <sup>2</sup>	RVV3×1.5mm <sup>2</sup>		
Electric lock wire	Wire between system power supply and electric lock		RVV2×0.75mm <sup>2</sup>	RVV2×1.0mm <sup>2</sup>	RVV2×1.5mm <sup>2</sup>	Except special electric lock	
220V power supply wire	Wire from AC to each heavy-current power supply		< 100m	< 200m	< 500m	Alternator Dual power supply	
			RVV3×1.0mm <sup>2</sup>	RVV3×1.5mm <sup>2</sup>	RVV3×2.0mm <sup>2</sup>		
Network Cable	Gate Station/Entrance Station /Master Station to LAN		Cat5 UTP 8 cores cable			please add Fiber Converter if over 100m	
Door phone wire	Wire between power supply and door phone		1~15m	15~30m	30~100m	Please pay attention to transmission distance and wire size	
			RVV2×0.5mm <sup>2</sup>	RVV2×0.75mm <sup>2</sup>	RVV2×0.75mm <sup>2</sup>		
	Wire between decoder and door phone		Cat5 UTP 8 cores cable			not more than 50m	
Alarm sensor wire	Wire between each sensor and door phone		1~20m	20~50m	50~100m	Please pay attention to transmission distance , wire size,sensor power: sensor connection and treatment for door phone mix alarm signal.Door phone provide the sensor with 15VDC voltage and 240mA electric current	
			Door Contact	RVV2×0.3mm <sup>2</sup>	RVV2×0.5mm <sup>2</sup>		RVV2×0.75mm <sup>2</sup>
			IR	RVV4×0.3mm <sup>2</sup>	RVV4×0.5mm <sup>2</sup>		RVV4×0.75mm <sup>2</sup>
			Gas	RVV4×0.3mm <sup>2</sup>	RVV4×0.5mm <sup>2</sup>		RVV4×0.75mm <sup>2</sup>
			Fire	RVV4×0.3mm <sup>2</sup>	RVV4×0.5mm <sup>2</sup>		RVV4×0.75mm <sup>2</sup>
	Emergency button		RVV2×0.3mm <sup>2</sup>	RVV2×0.5mm <sup>2</sup>	RVV2×0.5mm <sup>2</sup>		

Note: 1. When other products which are not our company are used with this products, related requirements are base on product standard and pay attention to their compatibility.

2. On the foundation above chart, if use our company Access Control system, no need independent wiring.

3. Please contact with our Technology Apartment if beyond the above chart.

# Wiring

UTP cable   
Multi-fiber copper wire 

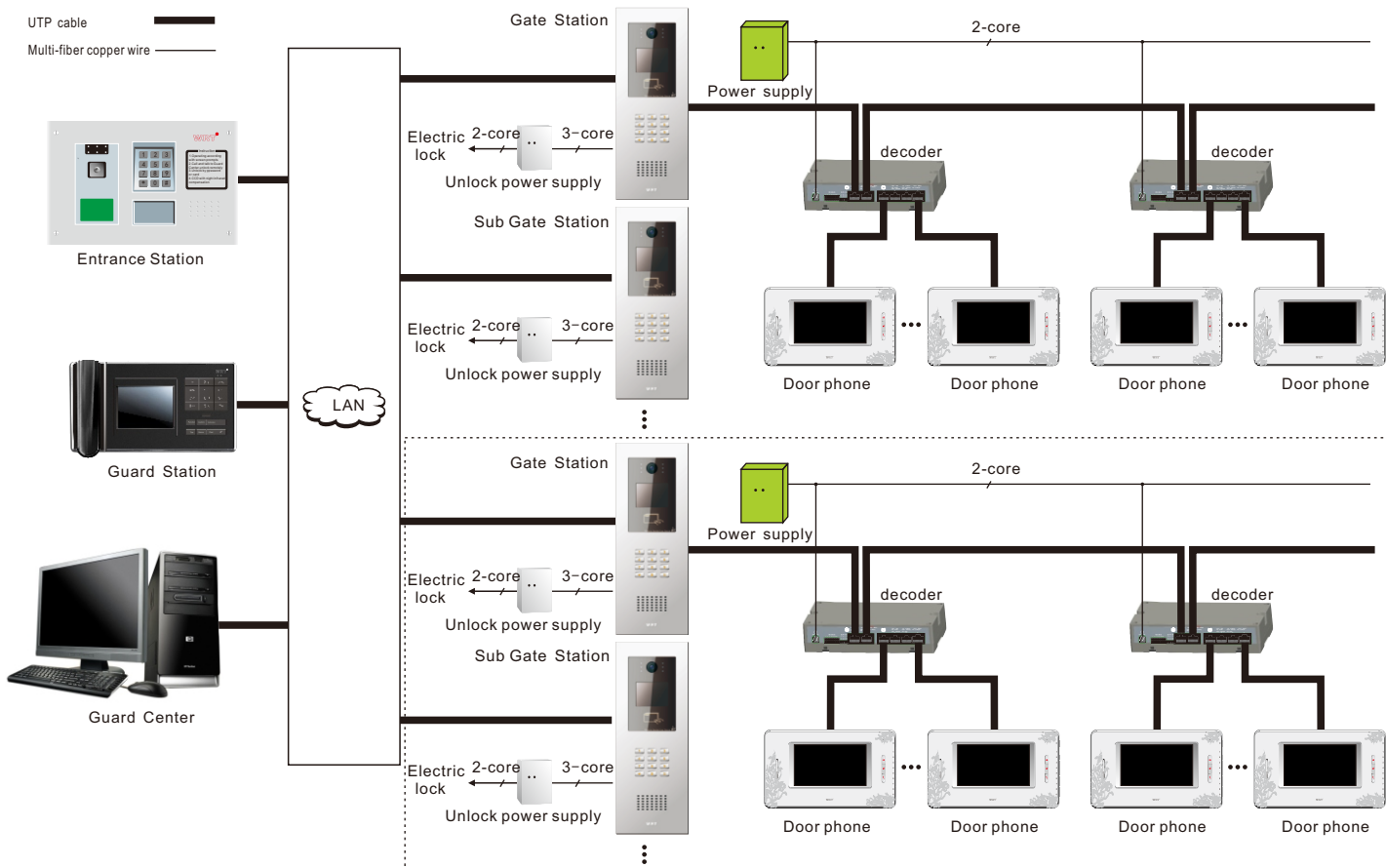

# Wiring

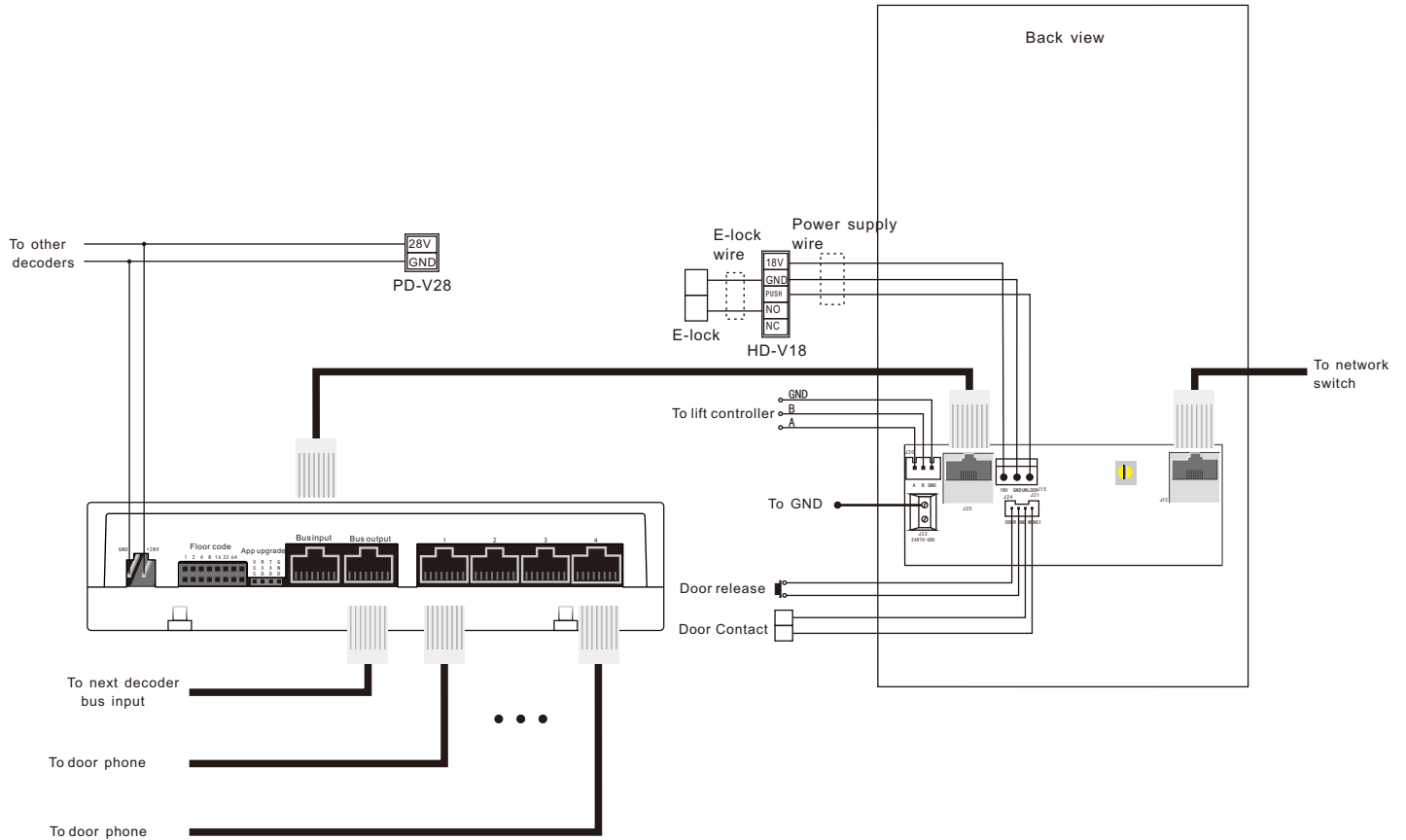



## **Manufacturer**

Shenzhen WRT Intelligent Electrical Appliance Co.,Ltd

Add: WRT Industrial Base, Dafu Industrial Park, Guanguang Rd,  
GuanLan Town, BaoAn District ShenZhen, China

Tel: +86 755 29576113

Fax: 86 755 29576023

Http:[www.wrt.sz.com](http://www.wrt.sz.com)